

The product pictures and the inscription surfaces illustrated (grey areas) are in a scale of 1:1. The inscription is placed by our experts inside these grey areas, observing optical and graphic rules, and in line with the request of the customer with regard to logo, letters/text.

● **Tampoprint** 

● **Hot stamping** 

Multi-purpose Pocket-Tools

«Original Swiss Army Knives»

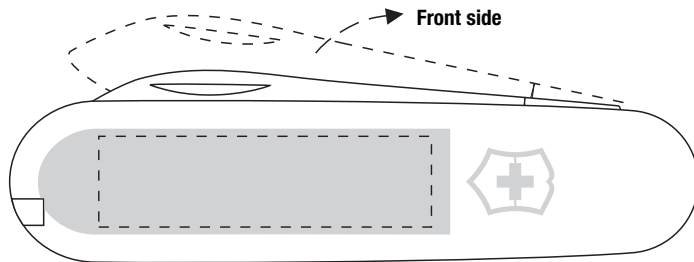

Front side with Emblem, length 91 mm

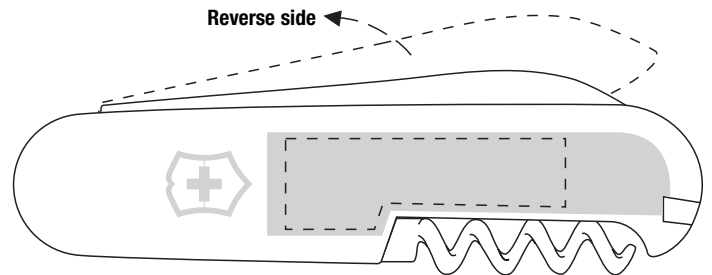

Reverse side with Emblem, length 91 mm

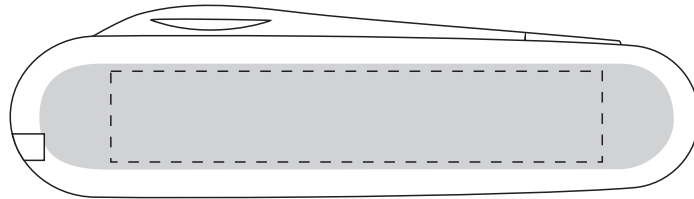

Front side without Emblem, length 91 mm

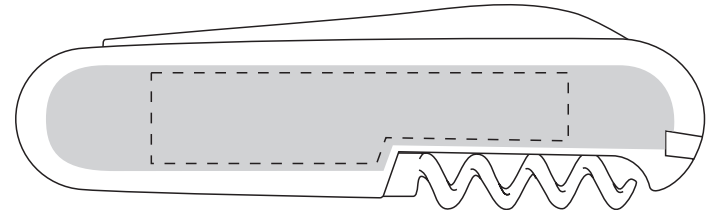

Reverse side without Emblem, length 91 mm

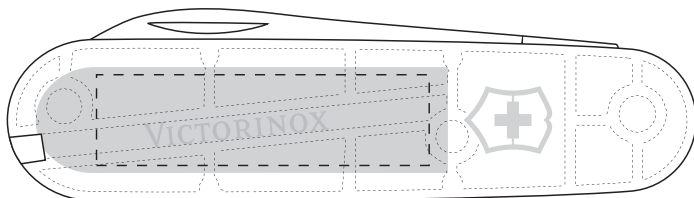

Front side translucent always with Emblem, length 91 mm

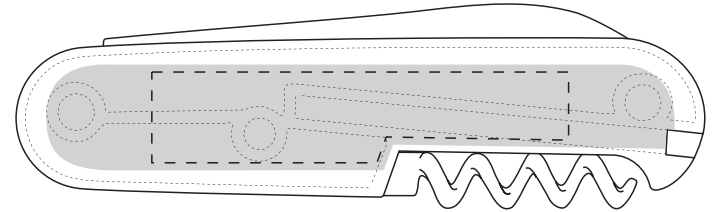

Reverse side translucent without Emblem, length 91 mm

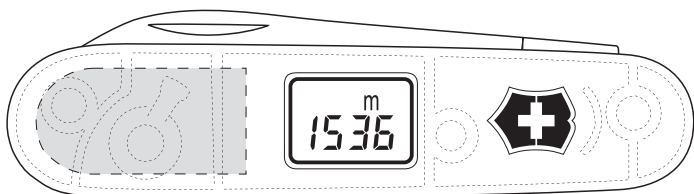

Front side translucent always with Emblem, length 91 mm, Altimeter and Voyager

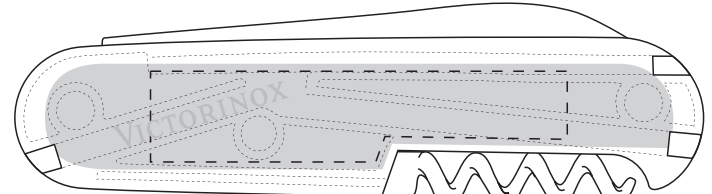

Reverse side translucent without Emblem, length 91 mm, Altimeter and Voyager

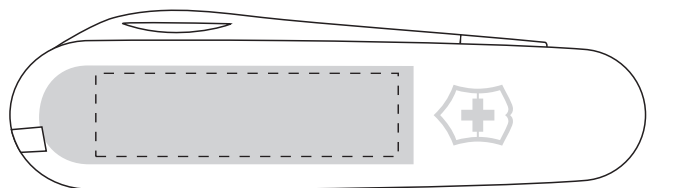

Front side with Emblem, length 84 mm

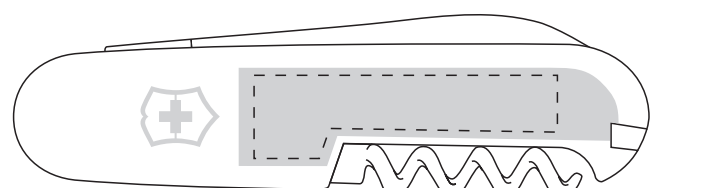

Reverse side with Emblem, length 84 mm

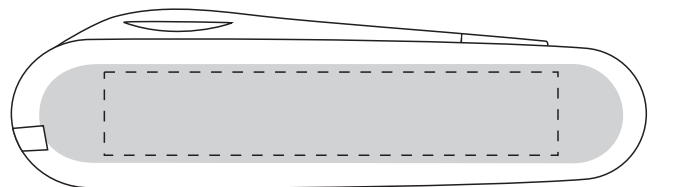

Front side without Emblem, length 84 mm

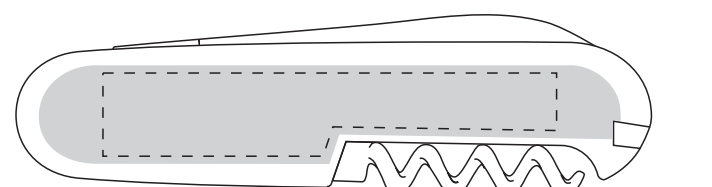

Reverse side without Emblem, length 84 mm

EcoLine

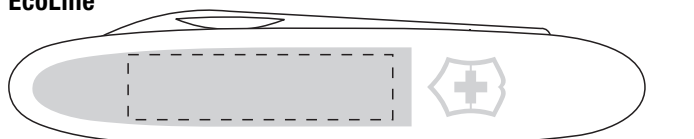

Front side with Emblem, length 84 mm

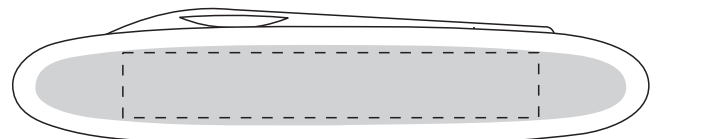

Front side without Emblem, length 84 mm
(reverse side with same surface)

For the other model sizes of the EcoLine series the same inscription information applies as for the «Original Swiss Army Knives» above.

Small, Elegant Pocket-Tools

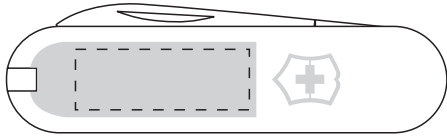

Front side with Emblem, length 58 mm

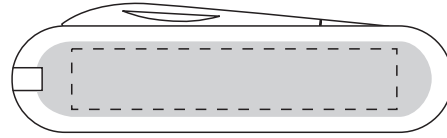

Front side without Emblem, length 58 mm (reverse side with same surface)

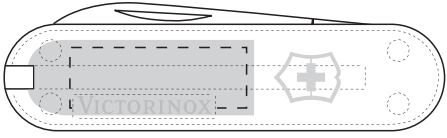

Front side translucent, length 58 mm

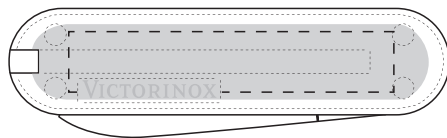

Reverse side translucent, length 58 mm

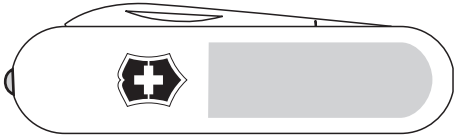

Front side with LED, Emblem is always on the front, length 58 mm

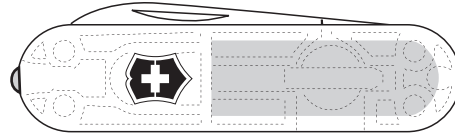

Front side translucent with LED, Emblem is always on the front, length 58 mm

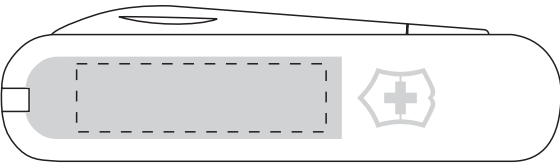

Front side with Emblem, length 74 mm

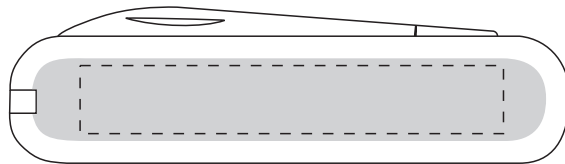

Front side without Emblem, length 74 mm (reverse side with the same surface)

Pocket-Multi-Tools with locking blade

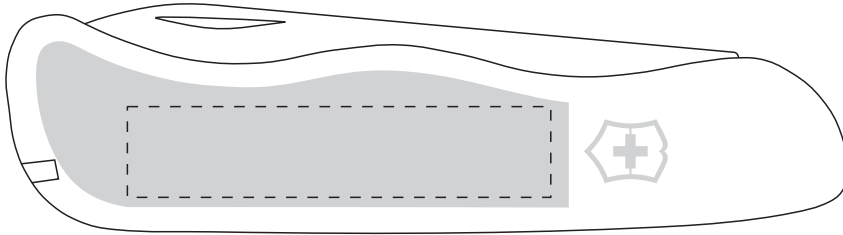

Front side with Emblem, length 111 mm

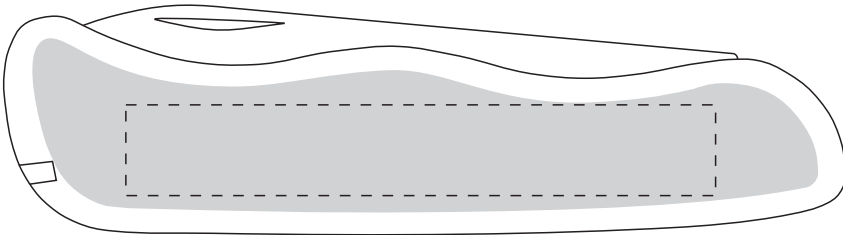

Front side without Emblem, length 111 mm

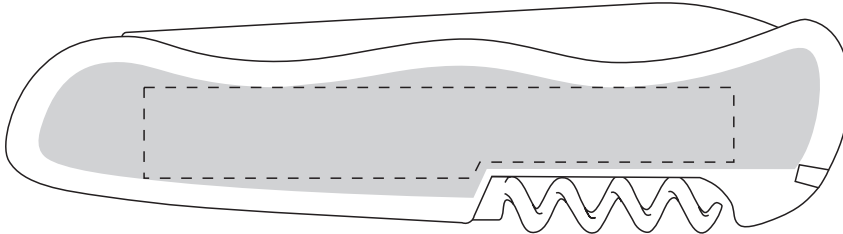

Reverse side, length 111 mm (for models 0.83.., 0.84.. with internal spring-release)

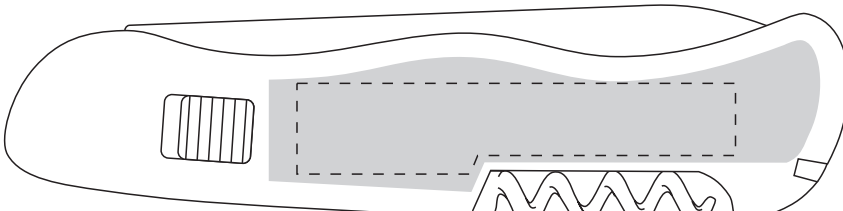

Reverse side with slider, length 111 mm (for models 0.88.., 0.89.., 0.90.. external locking-release by means of slider)

**Jura Color
Jura Alox**



Inscription surfaces
11 mm x 4 mm

Sportline Range



Men's version
9,5 mm x 3 mm
Ladies' version
7 mm x 2 mm

Field Watch



Men's version
13 mm x 4.5 mm
Ladies' version
10 mm x 3.5 mm

Peak



Men's version
11 mm x 4 mm
Ladies' version
9 mm x 3 mm

CROSS-Sets



Solo

Each inscription surface requires a separate die.

SwissCard Classic

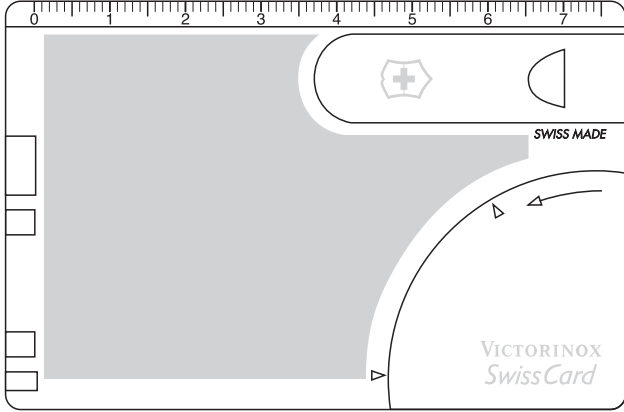

Front side

SwissCard Quattro

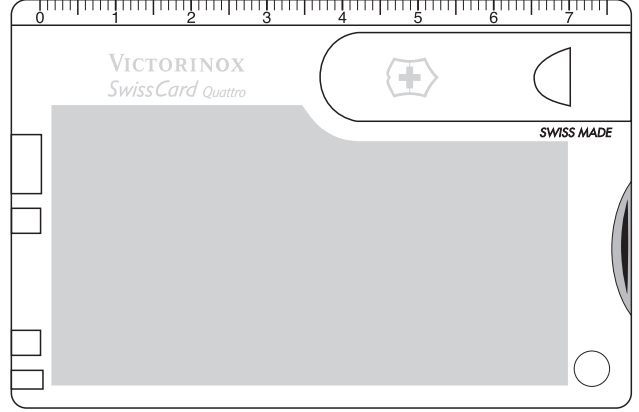

Front side

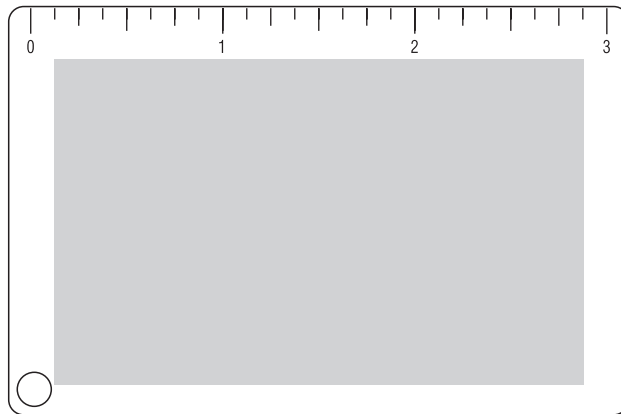

Reverse side SwissCard Classic/Quattro

GolfTool

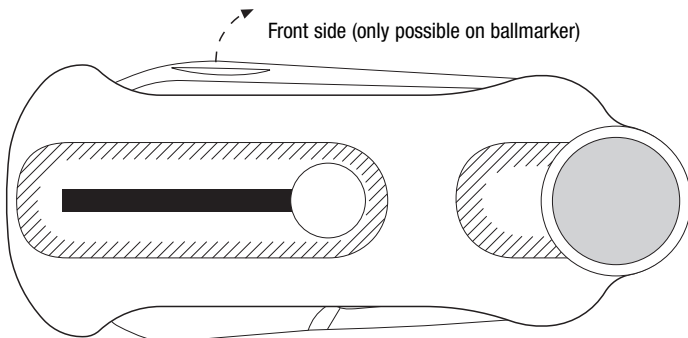

Front side (only possible on ballmarker)

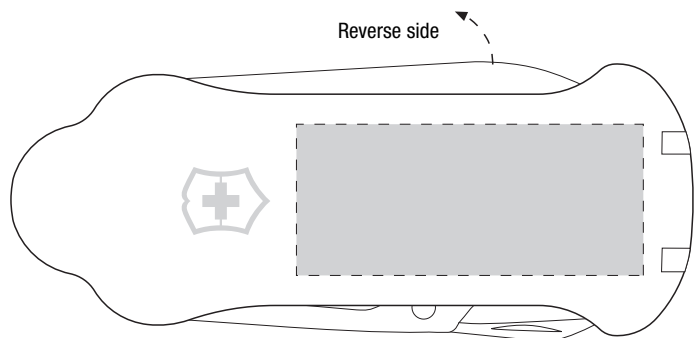

Reverse side

Additional ballmarkers



A.7090 with standard imprint

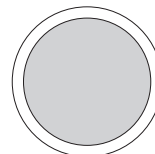

A.7090.0 (without imprint/priming) for customer specific imprint

Positioning of Metal Inlay

(only for polished Cellidor handles)

Metal inlays give the promotional article a valuable and up-market look provided they are kept discretely small. Below you will find some examples of good positioning of your company logos.

Multi-purpose Pocket-Tools

«Original Swiss Army Knives»

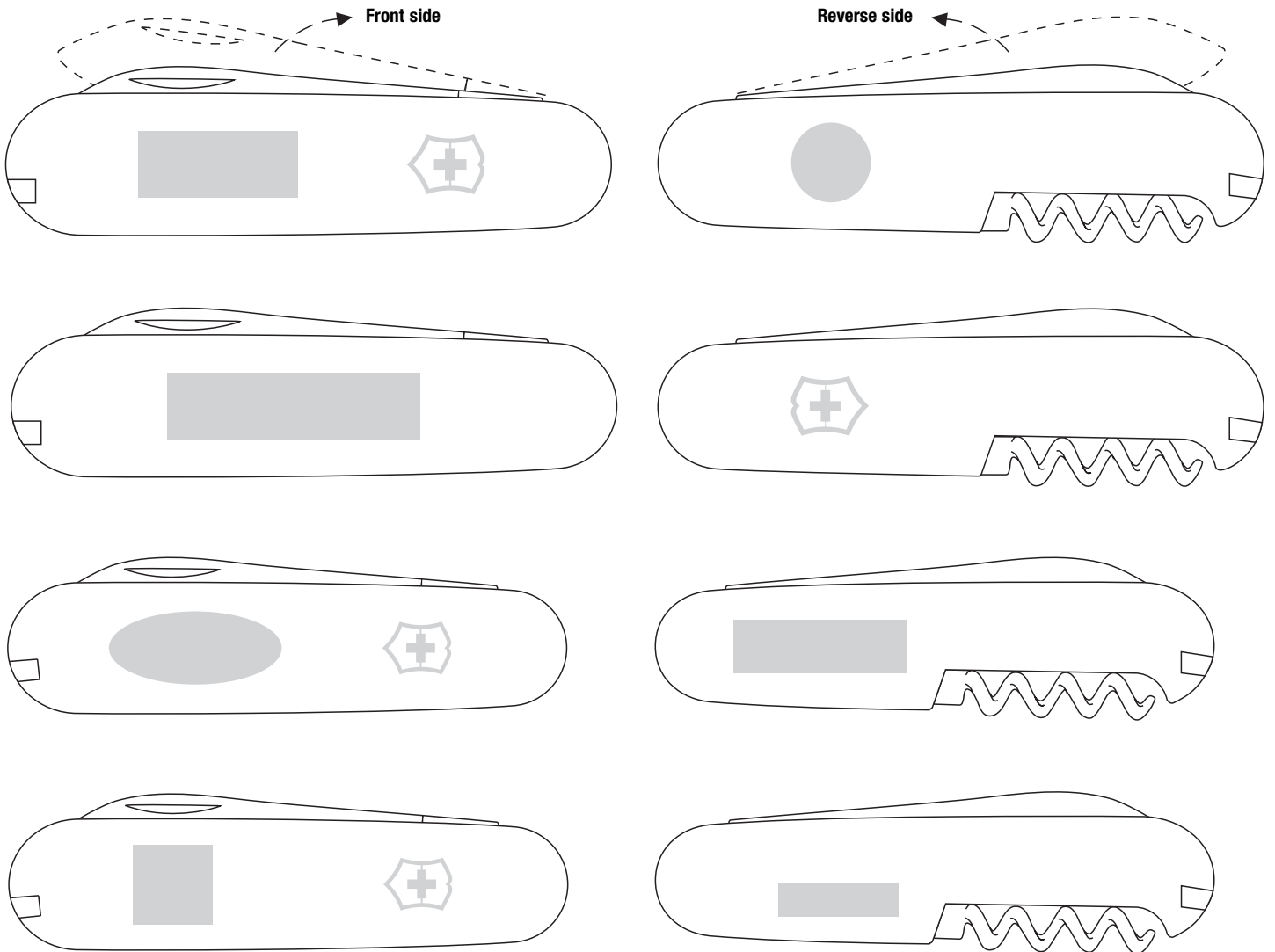

Small, Elegant Pocket-Tools

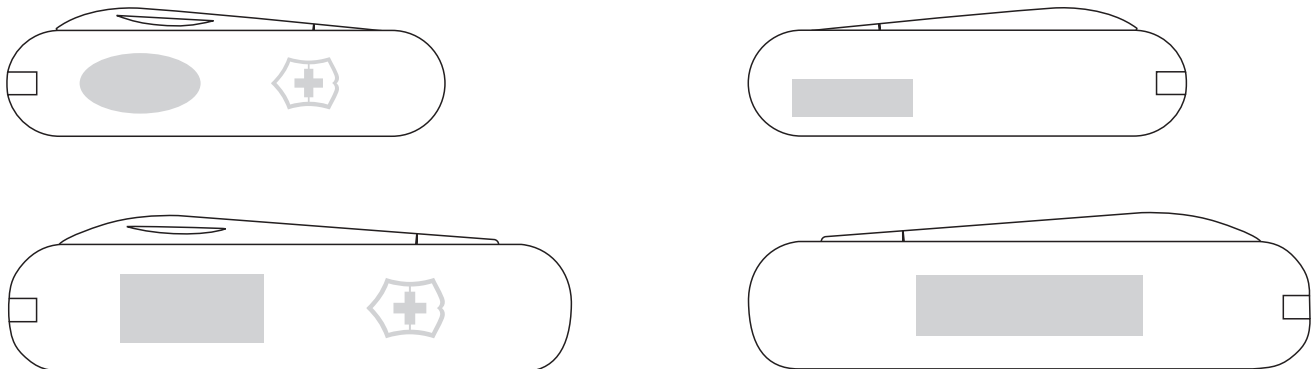

- SwissTool**
- **Tampoprint** (on handle)
 - **Etching** (on handle or blade)
 - **Diamond-Engraving** (on handle)

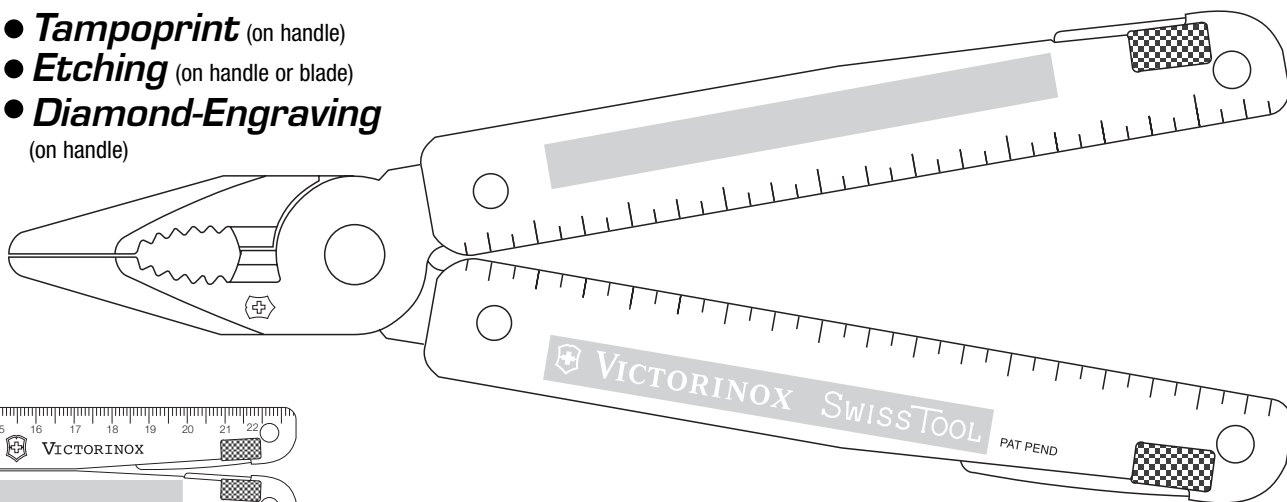

Front side: (scale 1:1)



Reverse side: (scale 1:2)

Reverse side: The VICTORINOX Logo is stamped into the metal.

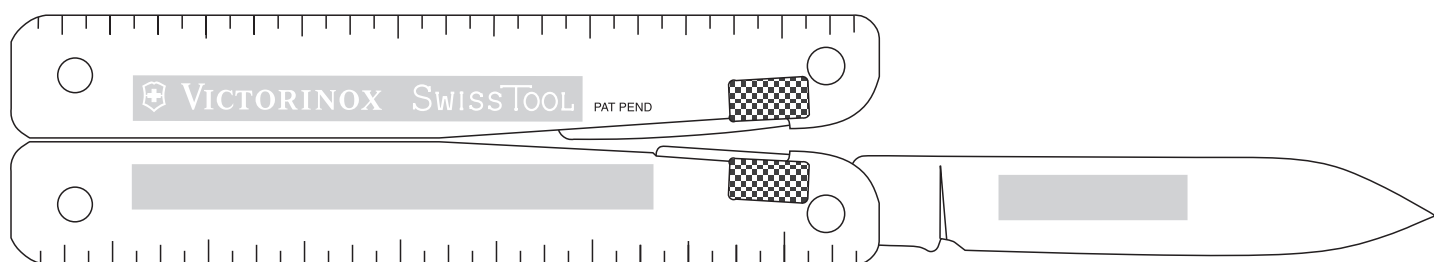

Important: It is essential to indicate the required position of the inscription and the orientation of the reading.

SwissTool Spirit



Front side: (scale 1:1)

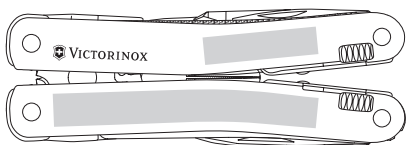

Reverse side: (scale 1:2)

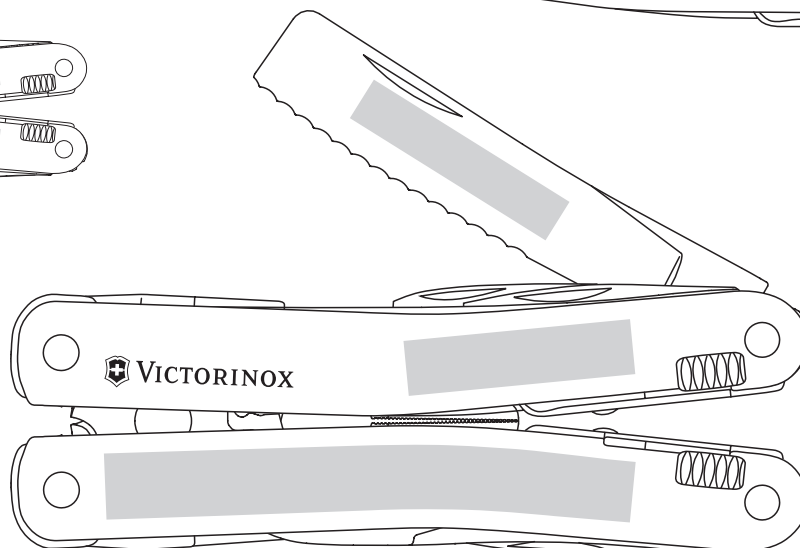

Important: It is essential to indicate the required position of the inscription and the orientation of the reading.